

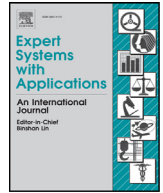

Contents lists available at ScienceDirect

Expert Systems With Applications

journal homepage: www.elsevier.com/locate/eswa

Video on demand recommender system for internet protocol television service based on explicit information fusion



Young-Duk Seo^a, Euijong Lee^b, Young-Gab Kim^{b,*}

^a Department of Data Science, Sejong University, Seoul, Republic of Korea

^b Department of Computer and Information Security, Sejong University, Seoul, Republic of Korea

ARTICLE INFO

Article history:

Received 11 July 2019

Revised 27 September 2019

Accepted 19 October 2019

Available online 30 October 2019

Keywords:

Internet protocol television

Over-the-top

Video-on-demand

Video on demand recommender system

Data sparsity problem

Information fusion

ABSTRACT

Internet protocol television (IPTV) provides video on demand (VOD), internet service, and real-time broadcasting to users as a service that combines broadcasting and communication technology. Among various services, the sales of VOD are profitable because VODs offer relatively strong direct revenue models in IPTV services. However, the development of a VOD recommender system for IPTV service is highly challenging owing to the lack of explicit preference information of users in an IPTV environment. Previous studies for IPTV VOD recommender systems have attempted to solve the data sparsity problem through implicit preference information; however, it is better to utilize explicit preference information to improve the performance of system. Recently, IPTV service providers have provided their own over-the-top (OTT) services such that explicit preference information of users for items can be combined. Therefore, we proposed a novel information fusion method for an IPTV VOD recommender system that integrates the explicit information of both IPTV and OTT services. In addition, we utilized the probabilistic matrix factorization, that guarantees high performance in most recommender systems, as a recommender algorithm in this study. Finally, we conducted comparative evaluations based on various metrics and validated that the information fusion of IPTV and OTT services contribute to the IPTV VOD recommender system.

© 2019 Elsevier Ltd. All rights reserved.

1. Introduction

Utilizing high-speed internet network, internet protocol television (IPTV) is a service combining broadcasting and telecommunication and provides users with video on demand (VOD) contents and internet service as well as real-time broadcasting (Bambini, Cremonesi & Turrin, 2011). Among them, VOD service was utilized as the most important attribute to measure the preference of user for IPTV services (Song, Jang & Sohn, 2009). In addition, the sales of various VOD contents, such as movie, animation, and drama, are the primary sources of revenue for IPTV service providers, who are attempting to provide users with various VOD contents (Kim, 2018). Therefore, it is important for IPTV service providers to develop an IPTV VOD recommender system that recommends VOD contents suitable for users. With the development of recommender systems, they can expect an increase in sales revenue and satisfied IPTV service users.

The specificity of the IPTV service environment, however, causes many difficulties in developing a recommender system

for IPTV compared to other domains (Bambini et al., 2011; Chang, Hightower & Kveton, 2009; Cremonesi & Turrin, 2010; Cremonesi, Turrin & Airoidi, 2011; Jang, Zhao, Hong, Park & Yi, 2016; Oliveira, Silva, de Abreu & Almeida, 2016; Vanattenhoven & Geerts, 2015; Zhang, Deng & Shi, 2017). First, it is difficult to identify users who are currently watching (Chang et al., 2009; Oliveira et al., 2016). As IPTV services are often used by families rather than by individual users, it is highly difficult task to correctly determine an individual user or a group of users who are currently watching. Next, it is difficult to obtain the preference information of users for items in the IPTV recommender system compared with other domains (Cremonesi & Turrin, 2010; Cremonesi et al., 2011). Although abundant information is available that can measure the preference of users through data input by them in other domains, in IPTV recommendation, unlike other domains, it is difficult to obtain preference information that is necessary for a recommender system because of the IPTV environment in which data input by users is inconvenient. This results in data sparsity problems that are directly related to the last problem. Finally, many requirements exist for building an UI for IPTV recommendation (Jang et al., 2016; Vanattenhoven & Geerts, 2015; Zhang et al., 2017). Unlike PC and mobile, the IPTV service does not involve interactive input devices such as a mouse or a touch

* Corresponding author.

E-mail addresses: mysid88@sejong.ac.kr (Y.-D. Seo), kongjjagae@sejong.ac.kr (E. Lee), alwaysgabi@sejong.ac.kr (Y.-G. Kim).

interface. Therefore, IPTV users have trouble inputting the preference information for items. In addition, in the IPTV recommender system, it is necessary to provide recommendations during real-time broadcasting; therefore, a constraint exists where recommendation results must be provided quickly and simply in real time. These reasons result in the lack of studies for the IPTV recommender system as compared with other domains despite its importance. Herein, we focus on solving the data sparsity problem caused by the difficulty in acquiring the preference information of users among the three problems mentioned above.

Studies on the IPTV recommender system have not been actively conducted compared to other domains. Few studies have addressed the low accuracy of recommendation as well as several issues in the IPTV recommender system. First, many studies utilized memory-based recommender algorithms that provide recommendation results by measuring the degree of similarity between users or items (Jin, Junhua, Suqi & Jian, 2017; Kim, Kim, Song, Song & Khil, 2012; Kim, Song, Song, & Kim et al., 2012; Park, Choi & Lee, 2010; Ullah, Sarwar & Lee, 2014; Xiao & He, 2012; Yang et al., 2014; Yang, Hu, He, Ni & Wang, 2015). These algorithms are inappropriate to solve the data sparsity problem, because the accuracy of recommendation is reduced when the data are not enough. Furthermore, an implicit preference information such as an IPTV watching log of users, which is easy to obtain in an IPTV environment, is utilized in many studies because of the difficulty in obtaining explicit preference information, such as rating (Cremonesi & Turrin, 2010; Jin et al., 2017; Kim, Kim et al., 2012; Kim, Kwon, Cho & Kang, 2011; Kim & Kang, 2013; Kim, Song et al., 2012; Ko, Kim, Ko & Chang, 2014; Park et al., 2010; Park, Han, Yang & Choi, 2017; Park, Oh & Yu, 2017; Sumiyoshi et al., 2010; Xiao & He, 2012; Xin & Steck, 2011; Yang et al., 2015; Zibriczky, Petres, Waszlavik & Tikk, 2013). Although the use of implicit information in the recommender system can solve the data sparsity problem, it generates a synergistic effect only when used with explicit information and does not guarantee recommendation accuracy when used alone (Ma, 2013).

Every IPTV service provider has aimed to improve the quality of the IPTV recommender system with over-the-top (OTT) media service which provides various media contents through the internet. IPTV provides contents through their set-top boxes, while OTT can deliver the same services as IPTV through mobile devices. Recently, they provided their OTT service or actively attempted to cooperate with OTT service providers (Park, 2018). For example, Korean IPTV service providers (e.g., SK Broadband, KT, and LG U+) provide their own OTT services (e.g., Oksusu, Olleh TV mobile, and Video portal) and IPTV services (e.g., B tv, Olleh TV, and U+ tv) simultaneously. Furthermore, many IPTV service providers have collaborated with OTT service provider such as YouTube and Netflix to strengthen their IPTV contents (Dwyer, Shim, Lee & Hutchinson, 2018). This flow of IPTV service markets implies that explicit information fusion between IPTV and OTT services is possible. Therefore, in this study, we propose a new method for an IPTV VOD recommender system extending explicit preference information to resolve the data sparsity problem. This method has not been considered in the existing IPTV recommender system studies. Furthermore, to improve the satisfaction of IPTV users for VOD contents, we propose an IPTV VOD recommender algorithm that provides them with suitable VOD contents using a highly accurate algorithm, such as probabilistic matrix factorization (PMF).

The contributions of this study are summarized as follows.

- (1) We proposed a method of explicit information fusion between IPTV and OTT services to solve the data sparsity problem occurring in the IPTV recommender system. The performance of the IPTV VOD recommender system based on this method was higher than that of the existing methods that

used the implicit preference to extend the explicit preference information of users for VOD contents.

- (2) Particularly, to improve the accuracy of the IPTV VOD recommender system, we proposed an IPTV VOD recommender algorithm based on PMF that is more accurate than memory-based recommender algorithms and sufficiently flexible to guarantee high performance in most domains. Therefore, the IPTV VOD recommender algorithm based on PMF outperformed the algorithms in the existing studies.
- (3) Several baseline algorithms were utilized for comparative evaluations through the IPTV and OTT data provided by the IPTV service provider in Korea. In addition, we measured the accuracy of the recommender algorithm based on the root mean squared error (RMSE) and mean absolute error (MAE). In addition, we proved the superiority of our proposed method by measuring the satisfaction of users for the recommended items based on precision, recall, and f1-measure metrics. According to experimental results, we verified that the performances of all recommender algorithms were improved when extending the IPTV data through the OTT data, and that PMF exhibited a higher performance than other recommender algorithms.

The remainder of this study is organized as follows. The existing studies related to the IPTV recommender system including its limitations are analyzed in Section 2. Section 3 describes the memory-based and model-based collaborative filtering recommender algorithms used in this study. Section 4 focuses on describing the IPTV VOD recommender system based on the data fusion of IPTV and OTT services. In Section 5, we explain the comparative evaluations that were conducted by utilizing the IPTV and OTT data and validate the performance of our proposed IPTV VOD recommender system based on the information fusion of both IPTV and OTT services. Finally, Section 5 presents the conclusions and future directions of this study.

2. Related Work

The accuracy of the IPTV recommender system has not been enough owing to the unique characteristics of the IPTV environment, although the importance of the recommender system has emerged in many research areas. In this study, we investigated the algorithms, preference information, experimental data, and recommended items that were used in the existing studies and analyzed whether information fusion was conducted. Table 1 presents the analysis of the existing studies.

Recommender systems are mainly based on three filtering methods, such as content-based filtering (CB), collaborative filtering (CF), demographic filtering (DF), and hybrid filtering (Bobadilla, Ortega, Hernando & Gutiérrez, 2013). Most recommender system studies mainly focused on utilizing CF rather than other filtering methods because of its effectiveness and efficiency (Seo, Kim, Lee & Baik, 2017). In addition, hybrid methods are generally the combination of CB and CF or DF and CF (Bobadilla et al., 2013; Burke, 2002; Inan, Tekbacak & Ozturk, 2018). Therefore, the IPTV recommender system is primarily based on the CF method, except in a few studies (Bhatt, 2009; Kim & Kang, 2013; Kim et al., 2011; Ko et al., 2014; Park, Han et al., 2017; Sumiyoshi et al., 2010). Some studies (Bhatt, 2009; Kim et al., 2011) utilized clustering algorithms to obtain the suitable set of items for users. Bhatt (2009) addressed the voting stuffing problem that occurs because most users do not change their preferences after entering their initial ratings. Therefore, they found the genuine rating set of users by utilizing the genre ratings and fuzzy c-means clustering algorithm. Kim et al. (2011) built a semantic relation among VOD

Table 1
Existing studies for IPTV recommender system.

	Algorithm		Preference info.		Data	Item	Info. fusion
	Method	Algorithm	Explicit	Implicit			
Bhatt (2009)	n/a	Fuzzy c-means clustering	Rating	n/a	IMDB ^a	VOD	n/a
Kim et al. (2011)	n/a	K-means clustering	n/a	Watching log	Unknown	VOD	n/a
Kim and Kang (2013)	n/a	Reasoning process based on ontology	n/a	Watching log, Shopping behavior	IPTV watching data (Nilson Research) ^b	Ad.	○
Ko et al. (2014)	n/a	Semantic cluster-based	n/a	Watching log	IPTV service in Korea	VOD	○
Sumiyoshi et al. (2010)	n/a	CB	n/a	n/a	IPTV service in Japan	VOD	n/a
Park, Han et al. (2017)	n/a	CB	n/a	Watching log	Their website	VOD	n/a
Park et al. (2010)	Memory-based	Hybrid filtering (CF + CB)	n/a	Watching log	IPTV watching data (Nilson Research)	VOD	○
Kim, Kim et al. (2012), Kim, Song et al. (2012)	Memory-based	User-based CF	n/a	Watching log	IPTV service in Korea	VOD	n/a
Xiao and He (2012)	Memory-based	User-based CF	n/a	Watching log	IPTV service in China	VOD	○
Ullah et al. (2014)	Memory-based	User-based CF	Rating	n/a	Yahoo multi-data Movie dataset ^c	VOD	n/a
Yang et al. (2014)	Memory-based	User-based CF	Rating	Watching log	Unknown	TV program	○
Yang et al. (2015)	Memory-based	Item-based CF, User-based CF	n/a	Watching log	IPTV service in China	TV program	n/a
Jin et al. (2017)	Memory-based	User-based CF	n/a	Watching log	Unknown	TV program	n/a
Cremonesi and Turrin (2010)	Memory-based, Model-based	Item-based CF, SVD	n/a	Watching log	IPTV service in Italy (ContentWise) ^d	TV program	n/a
Cremonesi et al. (2011)	Model-based	Hybrid filtering (CF + CB)	Rating	Pseudo rating	MovieLens, ContentWise	VOD	○
Xin and Steck (2011)	Model-based	PMF	n/a	Watching log	IPTV service in UK (BARB) ^e	TV program	○
Zibriczky et al. (2013)	Model-based	Tensor factorization	n/a	Watching log	IPTV service in Canada (SaskTel) ^f	TV program	○
Park, Oh et al. (2017)	Model-based	Tensor factorization	n/a	Watching log	TV rating measurement company in South Korea	TV program	○

^a <http://www.imdb.com>.

^b <https://www.nielsen.com>.

^c <http://research.yahoo.com/academicrelations>.

^d <https://www.contentwise.tv>.

^e <https://www.barb.co.uk>.

^f <https://www.sasktel.com>.

contents based on ontology and computed the users' preference for VOD content through the number of viewing times. Finally, they generated the recommended VOD contents through the K-means clustering algorithm. A clustering algorithm can group similar data easily; however, this is not a typically used algorithm to guarantee the effectiveness of the recommender system. The semantic relationship among users or items may be regarded as an important factor of IPTV recommendation (Kim & Kang, 2013; Ko et al., 2014). Kim and Kang (2013) developed an advertisement recommender algorithm in IPTV service to improve the performance and reusability of recommendation based on the ontology reasoning method. They did not focus on enhancing the accuracy of recommendation, but inferred semantic relations between heterogeneous ontologies, such as IPTV program ontology, viewer profile ontology, reference group ontology, product ontology, and advertisement ontology. Ko et al. (2014) proposed the semantic cluster-based recommender algorithm. First, they grouped contents with similar or related semantics into a single set and defined this set as a semantic cluster. Subsequently, they called the users who had consumed many content leading users and provided recommended results suitable for general users through their information. However, their proposed method might be only recommended popular contents having high influential in a semantic cluster. In other words, they experienced a problem with the low diversity of the recommended contents. In addition, CB was used in some studies (Park, Han et al., 2017; Sumiyoshi et al., 2010). The CurioView system (Sumiyoshi et al., 2010) is a content-based recommender system for IPTV service that allows users to retrieve contents associated with the content that they are currently watching; it is a flexible system that can be utilized on a TV, PC, or mobile phone. Park, Han et al. (2017) developed a system that provides recommendation through specific points in video using IPTV service. They defined the metadata for contents according to the key frames extracted from VOD contents. The preference of users for contents was measured by these defined metadata. CB is a popular approach in recommender systems along with CF. In a CB-based recommender system, data sparseness does not occur, but its effectiveness is lower than that of CF-based (Wang et al., 2017). Therefore, most studies on recommender systems, including IPTV service, have followed the CF approach (Cremonesi & Turrin, 2010; Cremonesi et al., 2011; Jin et al., 2017; Kim, Kim et al., 2012; Kim, Song et al., 2012; Park et al., 2010; Park, Oh et al., 2017; Ullah et al., 2014; Xiao & He, 2012; Xin & Steck, 2011; Yang et al., 2014, 2015; Zibriczky et al., 2013).

In the IPTV recommender system, CF has served as the primary source in most studies. Two primary methods exist in CF, such as memory-based and model-based (Alonso, Bobadilla, Ortega & Moya, 2019). The memory-based method is referred to as the neighborhood method (Seo et al., 2017) and primarily utilizes several k-nearest neighbor algorithms (i.e., Pearson correlation coefficient (PCC), cosine similarity (COS), and Jaccard measure etc.) to compute the similarity between users or items. Park et al. (2010) calculated the preference value for VOD contents according to the viewing times of users ranging from 0 to 1. Furthermore, they considered genre preference value and measured the final preference value of users for VOD contents based on these two preference values. Finally, they proposed a hybrid filtering method that combined CB and CF. They utilized the data from an audience measurement corporation to conduct a comparative evaluation. However, their data might be different from actual IPTV data provided by IPTV service providers. Kim, Kim et al. (2012) and Kim, Song et al. (2012) found groups with similar viewing patterns by utilizing their past viewing histories. They measured the similarity among users in the group through the PCC and Spearman's rank correlation coefficient. Finally, they generated the recommended results based on the predicted preference value that

is obtained by the predicted preference values through user-based CF. Xiao and He (2012) suggested two recommended algorithms, such as the tag-based CF algorithm and user template algorithm. The former is a traditional memory-based CF method based on the Jaccard similarity measure, whereas the latter can resolve new user problems by data extension through the information of influential users and other users of the same demographic group. Their recommender system is flexible because it can adopt algorithms that fit each scenario. Ullah et al. (2014) measured the similarity and mutual influence among users on SNS. However, this approach is not suitable for the IPTV recommender system because the IPTV environment does not form the relationship information among users, unlike SNS. Yang et al. (2014) categorized IPTV data to measure user preference, such as time slot information, viewing time of channel, and genre hierarchies. They regarded several types of data as the latent features to resolve the sparsity problem. Yang et al. (2015) developed an IPTV recommender system for family users. This system can identify the primary viewer who is currently watching TV by time zone and provide customized recommendations for each family member. Although the identification of the primary viewer is one of the main issues in the IPTV recommender system, this system exhibits high computational complexity because it measures the similarity twice. Jin et al. (2017) analyzed the data types for the IPTV recommender system that focused on the watching behavior of users. They extracted various features through the watching behavior of users to compute the score of TV programs. In addition, they utilized Apache Spark to improve the time efficiency. As mentioned above, various studies based on memory-based method have been conducted; however, this method generally exhibits lower performance than model-based methods in various domains (Koren, Bell & Volinsky, 2009). Several studies have validated the superiority of model-based method in terms of both effectiveness and efficiency in recommender systems (Forsati, Mahdavi, Shamsfard & Sarwat, 2014; Koren et al., 2009).

Typically, recommender system studies have primarily utilized model-based methods that generate recommendations through specific models, such as the neural network, fuzzy system, genetic algorithm, and latent factor model (Bobadilla et al., 2013). Among the various models, the latent factor model, which is also called the matrix factorization method, is the dominant model owing to its high accuracy and performance (Koren et al., 2009). In the IPTV environment, many studies based on several matrix factorization methods exist, such as singular value decomposition (SVD) (Cremonesi & Turrin, 2010; Cremonesi et al., 2011), PMF (Xin & Steck, 2011), and tensor factorization (Park, Oh et al., 2017; Zibriczky et al., 2013). Cremonesi and Turrin (2010) compared the accuracy of the recommender algorithms, such as SVD and item-based CF algorithm, according to temporal change and item popularity. However, they only analyzed the performance of the existing recommender algorithms and did not suggest a solution to solve the problems of the IPTV recommender system. Cremonesi et al. (2011) proposed a hybrid algorithm with low computational complexity for IPTV recommendation. In addition, they provided a solution to the new item problem that occurred in IPTV recommender systems because the number of items (i.e., IPTV contents) with ratings was extremely small. Even if they measured the pseudo rating through the features or metadata of items to increase the density of the user-to-item matrix, this rating is not related to the user preference for items. Therefore, their algorithm could not guarantee high effectiveness. Xin and Stech (2011) utilized both positive and negative feedbacks by distinguishing them through watching log of users when learning the implicit rating of items. They confirmed that their method demonstrated better performance than the existing methods using only positive feedback. Zibriczky et al. (2013) presented an interactive TV platform

focusing on the recommendation of an electronic program guide (EPG). They considered channels as items rather than TV programs because users tend to watch the same channel simultaneously. Furthermore, they considered the user behavior over time as an important factor in measuring the preferences of channels and focused on eliminating factors that adversely affect the preferences. Park, Oh et al. (2017) developed RecTime, a real-time recommender system for IPTV considering both time factor and preference. They utilized four features; user, item (i.e., TV program), watching log of user, and running time of items, and applied these features to four-dimensional tensor factorization to alleviate the noise of missing value. Most model-based studies for the IPTV recommender system have addressed the recommendation of TV programs or channels (Cremonesi & Turrin, 2010; Park, Oh et al., 2017; Xin & Steck, 2011; Zibriczky et al., 2013), instead of VOD, except one study (Cremonesi et al., 2011). However, because VOD presents a large effect on the sales of IPTV service providers, we must address the development of model-based IPTV VOD recommender systems with both high effectiveness and efficiency.

Generally, the existing IPTV recommender systems solve the data sparsity problem by extending or modifying the IPTV dataset. For example, most of them utilized the metadata of items or users (Cremonesi et al., 2011; Park, Han et al., 2017; Sumiyoshi et al., 2010) or the information of influential users (Ullah et al., 2014; Xiao & He, 2012). However, in the existing studies, this challenge is not addressed by integrating the preference information of users from external data sources other than IPTV. Therefore, to enhance the IPTV recommender system, we proposed a new information fusion approach between IPTV and OTT services for the same users.

3. Preliminary

Although PMF is a primary algorithm for an IPTV VOD recommender system in this study, we intend to represent that the performances of various CF-based recommender algorithms and PMF improve when the information used in the IPTV recommender system is extended through OTT information. Therefore, we describe the existing CF-based recommender algorithms focusing on memory-based and model-based methods before explaining the primary idea of this study.

3.1. Memory-based method

A memory-based method is also called a neighborhood method; it focuses on computing the similarity between items or users (Bobadilla et al., 2013). A user-oriented approach measures the preference of a target user for an item based on the information from a set of neighbor users. Neighbor users have with a similar tendency and interests of items to a target user. The final user-based CF algorithm oriented by user similarity is obtained by Eq. (1) (Konstas, Stathopoulos & Jose, 2009) that estimates the predicted preference value of a target user a for an item i ($\hat{r}_{a,i}$):

$$\hat{r}_{a,i} = \bar{r}_a + \frac{\sum_{u \in N_i^k(a)} (r_{u,i} - \bar{r}_u) w_{a,u}}{\sum_{u \in N_i^k(a)} w_{a,u}} \quad (1)$$

where $N_i^k(a)$ is the set of k -nearest neighbor users for user a that has the rated item i . \bar{r}_a and \bar{r}_i indicate the average preference values for all items rated by users a and u , respectively. In addition, $r_{u,i}$ represents the rating of a neighbor user u for an item i . $w_{a,u}$ signifies the similarity between user a and u , and it is the most important element in memory-based CF algorithms. Diverse similarity measures exist to calculate $w_{a,u}$. Among them, the PCC and COS are the most famous and widely used methods in recommender systems because of their effectiveness (Adomavicius & Tuzhilin, 2005). Therefore, we utilize these two similarity measures in this study,

and they are estimated by Eqs. (2) and (3), respectively, where $I_{a,u}$ is the set of all items that have been rated by both users a and u .

$$w_{a,u}^{PCC} = \frac{\sum_{i \in I_{a,u}} (r_{a,i} - \bar{r}_a)(r_{u,i} - \bar{r}_u)}{\sqrt{\sum_{i \in I_{a,u}} (r_{a,i} - \bar{r}_a)^2} \sqrt{\sum_{i \in I_{a,u}} (r_{u,i} - \bar{r}_u)^2}} \quad (2)$$

$$w_{a,u}^{COS} = \frac{\sum_{i \in I_{a,u}} r_{a,i} r_{u,i}}{\sqrt{\sum_{i \in I_{a,u}} r_{a,i}^2} \sqrt{\sum_{i \in I_{a,u}} r_{u,i}^2}} \quad (3)$$

The item-oriented approach, by contrast, utilizes the rating information of neighbor items by the same user to calculate his/her preference. The equation of the predicted preference value using item-based CF is almost similar to that of user-based CF, where $N_a^k(i)$ implies the set of k -nearest neighbor items for an item i that is rated by user a , and the item-based CF is computed by Eq. (4).

$$\hat{r}_{a,i} = \bar{r}_i + \frac{\sum_{j \in N_a^k(i)} (r_{a,j} - \bar{r}_j) w_{i,j}}{\sum_{j \in N_a^k(i)} w_{i,j}} \quad (4)$$

$w_{i,j}$ represents a version of similarity measure between items i and j , and it can be computed similarly as Eqs. (2) and (3), where $U_{i,j}$ implies the set of all users that have rated both items i and j ; $w_{i,j}$ is presented in Eqs. (5) and (6).

$$w_{i,j}^{PCC} = \frac{\sum_{u \in U_{i,j}} (r_{u,i} - \bar{r}_i)(r_{u,j} - \bar{r}_j)}{\sqrt{\sum_{u \in U_{i,j}} (r_{u,i} - \bar{r}_i)^2} \sqrt{\sum_{u \in U_{i,j}} (r_{u,j} - \bar{r}_j)^2}} \quad (5)$$

$$w_{i,j}^{COS} = \frac{\sum_{u \in U_{i,j}} r_{u,i} r_{u,j}}{\sqrt{\sum_{u \in U_{i,j}} r_{u,i}^2} \sqrt{\sum_{u \in U_{i,j}} r_{u,j}^2}} \quad (6)$$

User-based and item-based CF algorithms, which are memory-based methods, have been conducted for a long time (Bobadilla et al., 2013; Seo et al., 2017). However, they exhibit lower performances than model-based approaches in terms of both effectiveness and efficiency.

3.2. Model-based method

Unlike the memory-based method that considers the correlation between similar users or items, the model-based method primarily depends on matrix factorization (MF) among various models for a recommender system (Koren et al., 2009). The MF divides the matrix into low-dimensional latent vectors for the users and items to generate the recommended results. Therefore, this method is also known as the latent feature model.

Singular value decomposition (SVD) is the most basic MF algorithm (Sarwar, Karypis, Konstan & Riedl, 2000), where an $N \times M$ preference matrix \mathbf{R} exists, and the predicted rating matrix $\hat{\mathbf{R}}$ is given by the product of the latent feature matrices for the users \mathbf{U} and items \mathbf{V} as follows:

$$\hat{\mathbf{R}} = \mathbf{U} \cdot \mathbf{S} \cdot \mathbf{V}^T \quad (7)$$

\mathbf{U} and \mathbf{V} are the orthogonal matrices of size $N \times k$ and $M \times k$, respectively, where k is smaller than N and M ($k < N, M$). \mathbf{S} is a diagonal matrix of size $k \times k$. The latent feature vectors, p_a and q_i , are specified as the components of the matrices \mathbf{U} and \mathbf{V} . p_a is a latent feature vector associated with user a and is an a^{th} row of matrix \mathbf{U} . Meanwhile, q_i is associated with item i and is the i^{th} row of matrix \mathbf{V} . The predicted preference rating $\hat{r}_{a,i}$ is computed by the product of p_a and q_i , and is represented by Eq. (8).

$$\hat{r}_{a,i} = p_a \cdot q_i^T \quad (8)$$

The final $\hat{r}_{a,i}$ can be determined by the k -dimension that minimizes the squared error between the actual and predicted ratings as follows:

$$\min_{p^*, q^*} \sum_{(a,i) \in K} (r_{a,i} - \hat{r}_{a,i})^2 \quad (9)$$

where K is the set of (a, i) pairs when $r_{a,i}$ is not null. We utilized the stochastic gradient descent (SGD) as a minimization approach because of its easy use and time efficiency. SGD is represented by Eqs. (10)–(12) (Koren et al., 2009).

$$e_{a,i} = r_{a,i} - p_a \cdot q_i^T \quad (10)$$

$$p_a \leftarrow p_a + \gamma (e_{a,i} \cdot q_i - \lambda p_a) \quad (11)$$

$$q_i \leftarrow q_i + \gamma (e_{a,i} \cdot p_a - \lambda q_i) \quad (12)$$

SVD presents several advantages as compared to memory-based methods. First, it is generally better in recommendation effectiveness (i.e., accuracy) and time efficiency than item-based and user-based CFs. Furthermore, it can be coped with flexibly even if the number of users increases on the recommender system. In other words, SVD enhances scalability. Finally, it can be applied to the sparse matrix in the recommender system. However, over-fitting will likely occur.

To resolve the problem of over-fitting in the conventional SVD, Mnih and Salakhutdinov (2008) proposed the probabilistic approach (PMF) to control the over-fitting phenomenon. They utilized a regularization that involves adding a penalty term to Eq. (9) (i.e., error function). Eq. (13) represents the modified error function as follows:

$$\min_{p^*, q^*} \sum_{(a,i) \in K} (r_{a,i} - \hat{r}_{a,i})^2 + \lambda (\|p_a\|^2 + \|q_i\|^2) \quad (13)$$

where λ is a coefficient that implies the relative importance of the regularization term compared with the sum-of-squares error term. PMF could mitigate the problem of over-fitting and deliver high performance with high flexibility in various domains. However, this algorithm could not reflect the biases (i.e., variations) of rating values that are caused by the tendency of users to rate and thus result in the low diversity of recommendation results. Therefore, the biases of an individual user and item ($b_{a,i}$) must be considered (Koren et al., 2009) and it is represented by Eq. (14). The ratings with even distribution modified by the bias are given by the sum of the bias and the existing predicted rating (i.e., Eq. (8)), as described by Eq. (15). Eq. (16) represents PMF with bias added.

$$b_{a,i} = \mu + b_a + b_i \quad (14)$$

$$\hat{r}_{a,i} = b_{a,i} + p_a \cdot q_i^T \quad (15)$$

$$\min_{p^*, q^*} \sum_{(a,i) \in K} (r_{a,i} - \hat{r}_{a,i})^2 + \lambda (\|p_a\|^2 + \|q_i\|^2 + b_a^2 + b_i^2) \quad (16)$$

where μ represents the overall average rating in the recommender system; and b_a and b_i are the deviations of user a and item i , respectively. PMF with bias can prevent the recommended results that concentrate on popular items by considering the deviation. In addition, it exhibits higher effectiveness and accuracy compared to not considering bias. However, an additional cost is incurred in measuring the bias.

PMF is the most popular model-based method in the recommender system; however, other methods exist, such as SVD++ (Koren, 2008) and the non-negative matrix factorization (NMF) (Luo, Zhou, Xia & Zhu, 2014). Users tend not to rate their explicit

preferences (i.e., explicit rating range from 1 to 5). Therefore, many recommender system studies have utilized implicit preference to address data sparseness and the cold-start problem caused by the lack of explicit preference. SVD++ is a representative method to apply an implicit preference to the MF. Eq. (17) represents the modified rating that is utilized for SVD++:

$$\hat{r}_{a,i} = b_{a,i} + \left(p_a + |I_a|^{-\frac{1}{2}} \sum_{j \in I_a} y_{a,j} \right) \cdot q_i^T \quad (17)$$

where $y_{a,j}$ indicates whether user a has measured the rating for item j (i.e., $y_{a,j} = 1$ if the rating exists, 0 otherwise), and I_a corresponds to a set of items that are rated by user a . SVD++ utilizes Eq. (16) as an error function. This method has the advantage of complementing the sparse user-to-rating matrix; however, it results in increased costs owing to the additional implicit information.

NMF is a special case of MF where all elements of the latent feature matrix are positive. In other words, at each step of the SGD procedure, latent feature vectors, which are Eqs. (11) and (12), are updated by Eqs. (18) and (19), respectively.

$$p_a \leftarrow p_a \frac{\sum_{i \in I_a} q_i r_{a,i}}{\sum_{i \in I_a} q_i \hat{r}_{a,i} + \lambda_a |I_a| p_a} \quad (18)$$

$$q_i \leftarrow q_i \frac{\sum_{a \in U_i} p_a r_{a,i}}{\sum_{a \in U_i} p_a \hat{r}_{a,i} + \lambda_i |U_i| q_i} \quad (19)$$

where λ_a and λ_i are regularization parameters, and U_i corresponds to a set of all users who rates item i . NMF is a suitable method for clustering similar latent features and guarantees high performance in various research areas. However, this method exhibits poor performance in the sparse matrix; therefore, it demonstrates a relatively lower performance in the recommender system compared to the other domains.

In this study, we utilize various recommender algorithms, such as user-based CF, item-based CF, PMF, SVD++, and NMF, to conduct comparative evaluations. Based on these various algorithms, we validate the effect of information fusion of IPTV and OTT services in the IPTV recommender system.

4. IPTV VOD recommender system based on information fusion of IPTV and OTT services

We propose a novel information fusion approach for the IPTV VOD recommender system by combining the IPTV and OTT data. More specifically, the explicit information of IPTV is complemented by that of the OTT. Several IPTV provider companies provide their own OTT services or expand their VOD contents through partnerships with other OTT services. Therefore, information fusion between IPTV and OTT data is possible for the IPTV VOD recommender system. This information fusion approach contributes significantly to the IPTV VOD recommender system by solving the data sparseness problem and enhancing the accuracy of the recommendation results.

As shown in Fig. 1, we suggest a framework for our proposed IPTV VOD recommender system. The framework consists of four primary steps: data collection and processing, creating user-to-rating matrices for IPTV and OTT, information fusion of IPTV and OTT services, and IPTV VOD recommendation. In the first step, we describe our IPTV and OTT data provided by Zinnaworks Inc.¹ and the process of processing data. Subsequently, we create two user-to-rating matrices based on the explicit information of the IPTV

¹ <http://www.zinnaworks.com/>

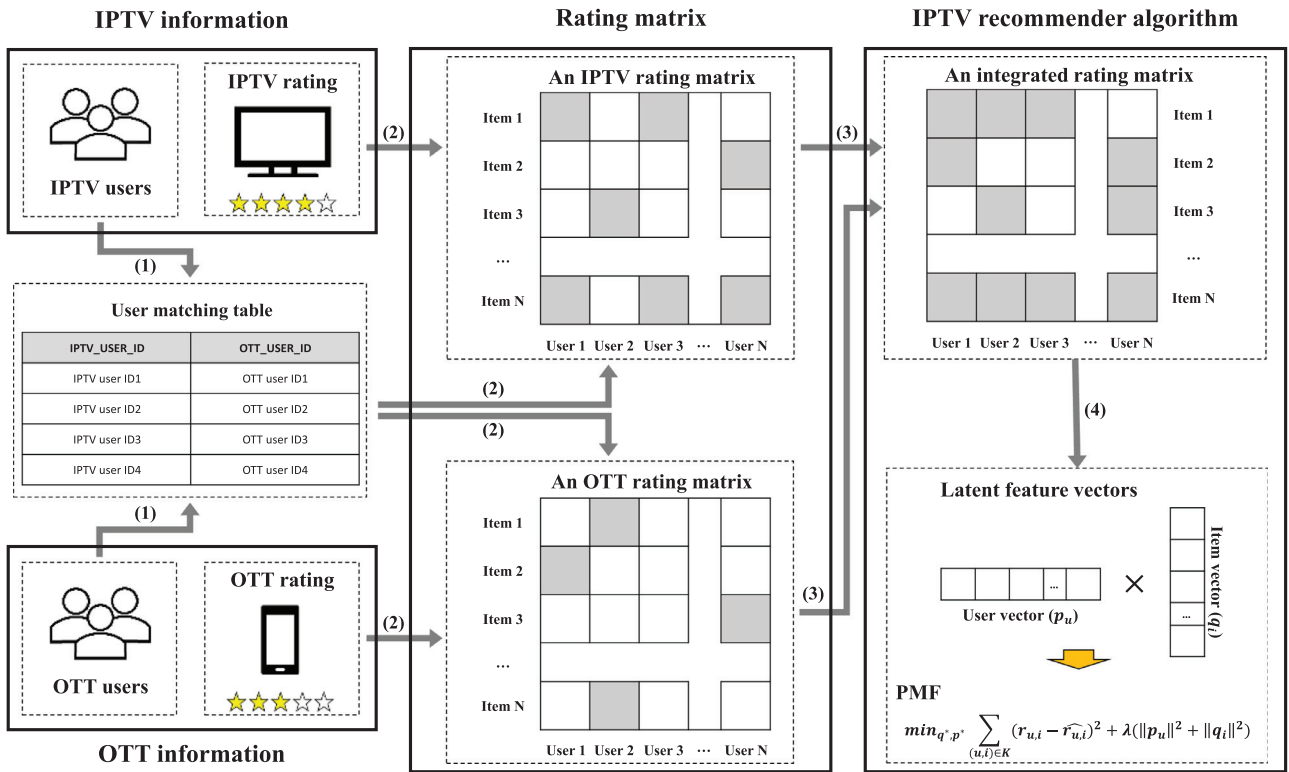

Fig. 1. Framework for IPTV VOD recommender system based on information fusion between IPTV and OTT services.

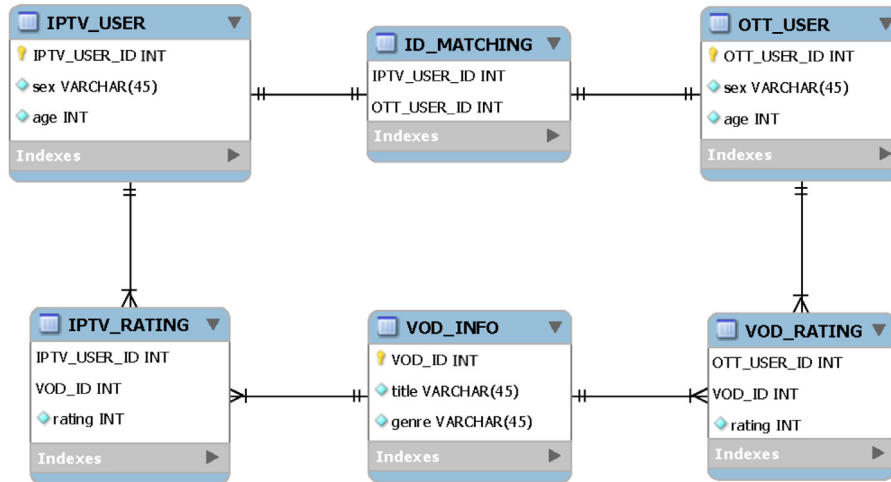

Fig. 2. ER diagram for the raw data of IPTV recommender system.

and OTT. Next, we combine two matrices as one integrated matrix for IPTV VOD recommendation. Finally, we derive the recommendation results from the various recommender algorithms, especially PMF, based on the integrated matrix.

Step 1. Data collection and processing. In this study, the log data of IPTV and OTT are provided by Zinnaworks Inc., a company that develops the various IPTV applications in South Korea. The provided data consist of user information, VOD information (movie), and rating information for IPTV and OTT. In addition, a user ID matching table is provided, and this is key for the information fusion of IPTV and OTT services.

First, we convert all log data to a relational database (RDB) that contains various tables as shown in Fig. 2, such as “IPTV_USER”, “OTT_USER”, “VOD_INFO”, “IPTV_RATING”, “OTT_RATING”, and “ID_MATCHING”. “IPTV_USER” and “OTT_USER” tables exhibit three

attributes related to users, such as user id, sex, and age. The “VOD_INFO” table contains three attributes related to movie VODs, such as VOD id, title, and genre. The “IPTV_RATING” and “OTT_RATING” tables are associated with the rating matrices of IPTV and OTT, respectively, and exhibit three attributes, such as user id, VOD id, and rating. Finally, the “ID_MATCHING” table represents the same user information as those of IPTV and OTT services through matching between two attributes, such as IPTV user id and OTT user id.

The table schemas used herein are as follows:

- IPTV_USER = (IPTV_USER_ID, sex, age)
- OTT_USER = (OTT_USER_ID, sex, age)
- VOD_INFO = (VOD_ID, title, genre)
- IPTV_RATING = (IPTV_USER_ID, VOD_ID, rating)

Table 2
IPTV and OTT services of IPTV providers.

Company	IPTV service	OTT service	Country
SK Broadband	Btv	Oksusu	Republic of Korea
KT	Olleh	Olleh TV mobile	Republic of Korea
LG U+	U+ TV	Video portal	Republic of Korea
Amazon	Prime Video	Prime Video	USA
Apple	Apple TV	Apple OTT	USA
AT&T/Direct TV	DirectTV	DirectTV now, mobile, and previews	USA
Google	YouTube TV	YouTube TV	USA
SaskTel	MaxTV Stream	MaxTV Stream	Canada
Fastweb	Fastweb	Chili TV	Italia

- $OTT_RATING = (OTT_USER_ID, VOD_ID, rating)$
- $ID_MATCHING = (IPTV_USER_ID, OTT_USER_ID)$

Steps 2 & 3. Creating an integrated user-to-rating matrix for IPTV recommender system. Before applying to the recommender algorithm, we convert the rating tables (i.e., “IPTV_RATING” and “OTT_RATING”) into two user-to-rating matrices for the IPTV and OTT. Subsequently, we create an integrated matrix for the IPTV recommender system to combine them.

These steps are key for the IPTV VOD recommender system to address data sparseness in this study. In the IPTV VOD recommender system, it is difficult to measure the preference rating of items (i.e., VOD) compared to other recommender system domains that contain abundant information to collect and calculate the preference of users for items. In the IPTV environment, UI is not user friendly because there are no user-friendly input devices such as a mouse or touch interface unlike a PC and mobile. In other words, this environment results in a difficulty in gathering data that can measure the users’ preference required for the recommender system. Therefore, in most IPTV recommender systems, data sparseness occurs and results in inaccurate recommendation results for users.

However, in recent years, IPTV providers have also been providing their mobile OTT services, as shown in Table 2. Because a similarity exists between the data collected in the IPTV and OTT services, this information fusion approach affects the performance of the IPTV VOD recommender system. In addition, we propose a fine-grained preference value of users for items ($r_{a,i}$) by weighing the average preference of the movie genre.

In this study, we denote $r_{a,i}^{IPTV}$ and $r_{a,i}^{OTT}$ as the preference values of user a for item i in the IPTV and OTT services, respectively. The final preference value for our proposed IPTV VOD recommender system is calculated by adding the genre weights to each preference value and combining them. First, we measure the average preference values for the movie genres and define the preference vectors of user a for genre g in the IPTV and OTT services as Eqs. (20) and (21).

$$r_{a,g}^{IPTV} = (\bar{r}_{a,g_1}^{IPTV} \quad \bar{r}_{a,g_2}^{IPTV} \quad \dots \quad \bar{r}_{a,g_n}^{IPTV}) \quad (20)$$

$$r_{a,g}^{OTT} = (\bar{r}_{a,g_1}^{OTT} \quad \bar{r}_{a,g_2}^{OTT} \quad \dots \quad \bar{r}_{a,g_n}^{OTT}) \quad (21)$$

where \bar{r}_{a,g_n}^{IPTV} and \bar{r}_{a,g_n}^{OTT} are the average preference value of r_{a,g_n}^{IPTV} and r_{a,g_n}^{OTT} , and n is the number of genre. Furthermore, the range of each vector value of $r_{a,g}^{IPTV}$ and $r_{a,g}^{OTT}$ is normalized between 0 and 1 through min-max normalization.

Additionally, we define the item-genre vector i_g to measure the genre weight. This vector represents the genres included in the item i and is defined as Eq. (22).

$$i_{g_n} = \begin{cases} 1 & \text{if } i \text{ includes } g_n \\ 0 & \text{else} \end{cases} \quad (22)$$

$$i_g = (i_{g_1} \quad i_{g_2} \quad \dots \quad i_{g_n})$$

The final genre weight is measured by the inner product between the genre preference vector of the user (i.e., $r_{u,g}^{IPTV}$ and $r_{u,g}^{OTT}$) and item-genre vector i_g . Eqs. (23) and (24) represent the genre weights of the IPTV and OTT services, respectively.

$$w_{a,i}^{IPTV} = \frac{i_g \cdot r_{a,g}^{IPTV}}{\|i_g\|^2} \quad (23)$$

$$w_{a,i}^{OTT} = \frac{i_g \cdot r_{a,g}^{OTT}}{\|i_g\|^2} \quad (24)$$

The fine-grained preference value of user a for item i is computed by adding the genre weight to the original preference value $r_{a,i}$. In addition, we consider the interval of rating d . For example, if the rating is 1, 2, 3, 4, 5, d corresponds to 1, however, if the rating is 0.5, 1, ..., 4.5, 5, then d corresponds to 0.5. This interval value could prevent low rating items from becoming higher than the high rating items (i.e., if $r_{a,i_1} = 4$ and $r_{a,i_2} = 5$, r_{a,i_1} will never become higher than r_{a,i_2}). Eqs. (25) and (26) indicate the fine-grained preference values for IPTV and OTT services, respectively, and Eq. (27) represents the final fine-grained preference value for our IPTV VOD recommender system in this study.

$$r'_{a,i}^{IPTV} = d w_{a,i}^{IPTV} + r_{a,i}^{IPTV} \quad (25)$$

$$r'_{a,i}^{OTT} = d w_{a,i}^{OTT} + r_{a,i}^{OTT} \quad (26)$$

$$r_{a,i} = \begin{cases} r'_{a,i}^{IPTV} & \text{if } r'_{a,i}^{IPTV} \neq \text{null and } r'_{a,i}^{OTT} = \text{null} \\ r'_{a,i}^{OTT} & \text{else if } r'_{a,i}^{IPTV} = \text{null and } r'_{a,i}^{OTT} \neq \text{null} \\ (r'_{a,i}^{IPTV} + r'_{a,i}^{OTT})/2 & \text{else if } r'_{a,i}^{IPTV} \neq \text{null and } r'_{a,i}^{OTT} \neq \text{null} \\ \text{null} & \text{else} \end{cases} \quad (27)$$

Step 3. Generating recommendation results. In this study, we utilize PMF, i.e., Eqs. (13) and (16), as an IPTV VOD recommender algorithm because it guarantees high performance in most domains. In addition, we utilize SGD, i.e., Eqs. (10)–(12), as a learning method for the model-based approach.

5. Experiments and evaluation

We conducted an experiment and validated the superiority of our proposed information fusion approach for the IPTV VOD recommender system. We utilized RMSE, MAE, precision, recall, and f1-measure as the accuracy metrics to compare the results of only IPTV data and integration of IPTV and OTT data. In addition, we evaluated memory-based and model-based recommender algorithms. The former consists of user-based CF (Jin et al., 2017; Kim, Kim et al., 2012; Kim, Song et al., 2012; Ullah et al., 2014; Xiao & He, 2012; Yang et al., 2014, 2015) and item-based CF (Cremonesi & Turrin, 2010; Yang et al., 2015) based on the PCC and COS, and the latter consists of NMF (Luo et al., 2014), SVD++ (Koren, 2008), and PMF (Cremonesi & Turrin, 2010; Xin & Steck, 2011).

Table 3
Dataset for experiment.

#Users			# Ratings		#Items	#Genres
IPTV	OTT	Active users	IPTV	OTT		
155,906	82,841	2957	213,074	82,827	636	21

5.1. Dataset

In this study, we utilized the data related to the explicit preference information of users in the Korean IPTV and OTT services provided by Zinnaworks Inc. as shown in Table 3. First, based on 1000 popular movies, we collected the information of users who rated those movies. We extracted 155,906 IPTV users and 82,841 OTT users, and they had 213,074 ratings and 82,827 ratings respectively. Subsequently, to ensure a precise experiment, we found 2957 active users who have many ratings and both IPTV and OTT IDs in the provided raw data. In addition, we collected the genre information related to each item by utilizing an open API in the Korean Film Council (KOFIC).² KOFIC divides the movie genre into 21 categories, such as drama, comedy, action, melodrama/romance, thriller, mystery, horror, adventure, crime, family, fantasy, SF, western, historical drama, animation, documentary, war, musical, adult, performance, and unknown.

5.2. Accuracy of recommender algorithm

We validated the quality of the recommendation results from our IPTV VOD recommender system using the RMSE and MAE. They are widely utilized to measure the accuracy of recommender algorithms for IPTV systems (Ullah et al., 2014; Yang et al., 2014). By measuring them, we first verified that extending the data of the IPTV VOD recommender system through OTT data improved the recommendation performance. Furthermore, we proved that PMF is more accurate than other recommender algorithms, such as user-based CF, item-based CF, SVD++, and NMF.

The RMSE and MAE calculate the difference between predicted and original ratings (Bobadilla et al., 2013; Seo et al., 2017). In other words, they are the error measurements of the predicted rating calculated by the recommender algorithms. Therefore, the smaller the MAE and RMSE values, the better is the recommendation performance. To measure the RMSE and MAE, we must obtain a set of items of which the predicted and original ratings are not null values, and this set is defined by Eq. (28), where I_a implies all items are rated by user a .

$$\hat{R}_a = \{i \in I_a \mid r_{a,i} \neq null \wedge \hat{r}_{a,i} \neq null\} \tag{28}$$

After obtaining a \hat{R}_a , we can easily compute the RMSE and MAE that are defined in Eqs. (29) and (30), respectively, as follows:

$$MAE = \frac{1}{|U|} \sum_{a \in U} \left(\frac{1}{|\hat{R}_a|} \sum_{i \in \hat{R}_a} |r_{a,i} - \hat{r}_{a,i}| \right) \tag{29}$$

$$RMSE = \frac{1}{|U|} \sum_{a \in U} \sqrt{\frac{1}{|\hat{R}_a|} \sum_{i \in \hat{R}_a} (r_{a,i} - \hat{r}_{a,i})^2} \tag{30}$$

where U denotes all users in the recommender system.

Fig. 3 represents the results of accuracy with regard to various recommender algorithms including PMF. As shown in Fig. 3, the accuracy of the recommender algorithms was improved in all cases, except in the RMSE of item-based CF. Table 4 represents the accuracy improvement rate when IPTV data are supplemented

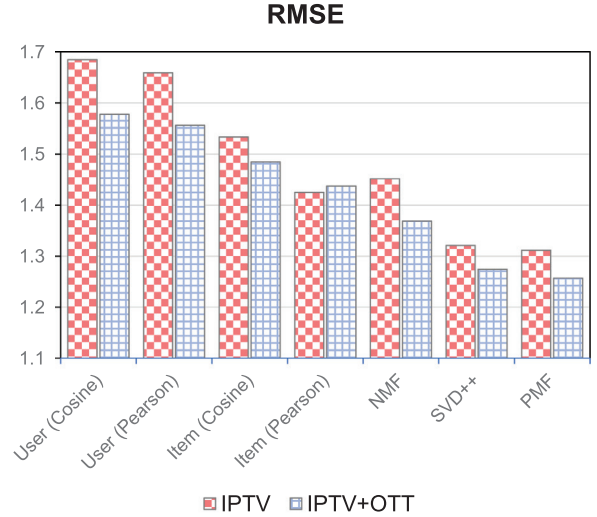

(a) RMSE

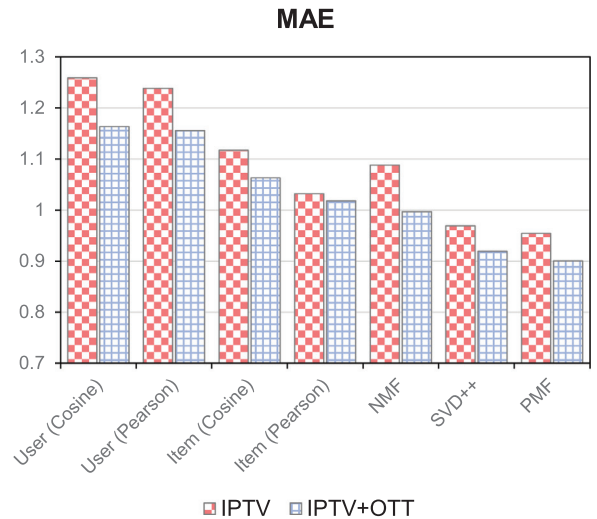

(b) MAE

Fig. 3. Accuracy of various recommender algorithms for an IPTV VOD recommender system.

with OTT data in detail. According to the accuracy results shown in Fig. 3 and Table 4, we verified that the information fusion approach that combined IPTV and OTT data could be beneficial to the IPTV VOD recommender system.

Furthermore, we describe the experimental results of each algorithm in more detail as follows. First, we compare the memory-based methods with model-based methods. The former corresponds to item-based CF and user-based CF, while the latter

Table 4
Accuracy improvement ratio when OTT data are added to IPTV data (%).

Algorithms		RMSE	MAE
User-based CF	COS	6.78	8.20
	PCC	6.59	7.18
Item-based CF	COS	3.27	5.09
	PCC	-0.88	1.37
SVD++		3.68	5.41
NMF		6.06	9.14
PMF		4.32	5.99

² <http://www.kobis.or.kr/>

corresponds to SVD++, NMF, PMF. As with previous studies (Lee, Sun & Lebanon, 2012; Ma, 2013), all model-based methods demonstrated higher accuracy than memory-based methods. In the IPTV environment, the ratio of ratings in the user-to-rating matrix is extremely low. This affects the accuracy of the recommender algorithms, especially memory-based approaches because they focus on measuring similarity based on ratings. Next, comparing between the two memory-based methods, item-based CF demonstrated better accuracy than user-based CF. The number of users rated for one item is typically higher than the number of ratings for one user; as such, similarity of item-based CF is measured more exactly than that of user-based CF. Therefore, the performance of item-based CF is generally better because the accuracy of similarity measurement affects the performance of the overall recommender system. In the case of SVD++, the accuracy was almost similar to those of PMF but slightly lower. As SVD++ considers both the implicit and explicit ratings, it generally demonstrates higher accuracy than when only explicit rating is considered. However, in the IPTV environment, SVD++ is not an appropriate method when only the number of ratings is considered as an implicit rating. In the case of NMF, this algorithm has been utilized in many research areas because it is highly effective for clustering similar patterns of latent features. However, in NMF, the results were not consistent in particular, and it did not guarantee the performance in recommender systems. In Fig. 3, we verified that the accuracy of NMF was generally lower than those of other model-based methods. Finally, PMF outperformed other recommender algorithms, in particular, user-based CF, item-based CF, and NMF as shown in Fig. 3. Their accuracies were almost similar to that of SVD++, but their overall performance is relatively higher than that of SVD++ because their calculation costs were much lower than that of SVD++.

5.3. Quality of users' satisfaction for recommended items

Although the RMSE and MAE are suitable metrics to measure the accuracy of recommender algorithms, they cannot be used to evaluate the satisfaction of users for recommended items. Therefore, we utilized precision, recall, and f1-measure to quantify the satisfaction of users (Bobadilla et al., 2013; Seo et al., 2017). These metrics have been utilized in various recommender system studies; they indicate the number of movies that have interested users in a recommended items list. Park et al. (2010) utilized precision to evaluate their hybrid IPTV VOD recommender system. Bambini et al. (2011) used recall to compute the performance of their channel recommendation in an actual IPTV environment (i.e., ContentWise³ recommender system in Fastweb⁴). Park, Oh et al. (2017) validated their real-time IPTV recommender system based on precision, recall, and f1-measure.

If Z_a implies the set of k recommended results (i.e., items) to user a , Eqs. (31) and (32) represent the special sets for calculating precision, recall, and f1-measure.

$$L_a^k = \{i \in Z_a \mid r_{a,i} \geq \theta\} \quad (31)$$

$$P_a^k = \{i \in I_a \mid r_{a,i} \geq \theta\} \quad (32)$$

L_a^k and P_a^k denote the number of items that user a prefers in the set of Z_a and I_a , respectively; that is to say, the number of items that exceed a certain threshold θ . After defining L_a^k and P_a^k , we can calculate the precision, recall, and f1-measure. Eqs. (33)–(35) in-

Table 5
Satisfaction improvement ratio when OTT data are added to IPTV data (%).

Algorithms		Precision		Recall		F1	
		$k=5$	$k=10$	$k=5$	$k=10$	$k=5$	$k=10$
User-based CF	COS	32.04	28.85	3.20	1.81	27.30	26.45
	PCC	26.89	27.45	1.35	0.57	22.69	25.01
Item-based CF	COS	38.99	38.47	8.28	7.68	33.93	35.68
	PCC	52.21	51.58	13.46	13.75	45.69	48.11
SVD++		40.47	37.66	8.48	7.94	35.20	34.97
NMF		52.55	49.81	15.47	14.93	46.35	46.64
PMF		53.11	52.74	16.84	16.14	47.02	49.38

dicating how they are calculated (Bobadilla et al., 2013; Seo et al., 2017).

$$precision = \frac{1}{|U|} \sum_{a \in U} \frac{|L_a^k|}{k} \quad (33)$$

$$recall = \frac{1}{|U|} \sum_{a \in U} \frac{|I_a^k|}{|P_a^k|} \quad (34)$$

$$F1 = \frac{2 \times precision \times recall}{precision + recall} \quad (35)$$

Precision indicates the ratio of preferred items for users from the top k recommended items, while recall indicates the ratio of preferred items in the top k recommended items from all the preferred items of the users. In addition, the f1-measure considers both the precision and recall.

Figs. 4 and 5 represent the results of precision, recall, and f1-measure for the IPTV VOD recommender system. We set the number of top k recommended results to 5 and 10 (i.e., $k=5, 10$). In case of utilizing only IPTV data, we verified that the performance of model-based methods including PMF was slightly lower than those of memory-based methods. This is because a small number of preference information of users affects the users' satisfaction measurements, such as precision, recall, and f1-measure; hence, the precise measurements are difficult to compute. Particularly, the low preference ratio affects the performance of precision. In other words, as shown in Figs. 4 and 5, precision is much lower than recall in all cases.

However, the results of all algorithms improved when the IPTV and OTT data were integrated with the results of Figs. 4 and 5. In particular, as shown in Table 5, precision increased by about 42%, recall by about 9%, and f1-measure by about 37% as compared with only utilizing IPTV data. Among all algorithms, PMF demonstrated the best results of the users' satisfaction measurements and their improvement ratios in all cases as expected. In addition, unlike the results of RMSE and MAE, item-based CF demonstrated higher satisfaction measurements than NMF and SVD++, and a similar tendency was often observed in other IPTV recommender systems (Bambini et al., 2011; Cremonesi & Turrin, 2010; Cremonesi et al., 2011).

We tested two aspects, i.e., the accuracy of the recommender algorithms and the satisfaction measurements of users, to demonstrate the effectiveness of IPTV and OTT data integration. The accuracy of model-based methods was better than those of memory-based methods in all cases. Meanwhile, memory-based methods exhibited higher satisfaction of users than model-based methods when only IPTV data were used. In particular, the satisfaction values of item-based CF were improved significantly in the memory-based method when IPTV and OTT data were integrated. However, in this study, we focused on the integration of IPTV and OTT data and confirmed that this integration affected the performance of the IPTV VOD recommender system positively. In addition, the performance of PMF was the best when OTT data were added to the IPTV

³ <https://www.contentwise.tv/>

⁴ <https://www.fastweb.com/>

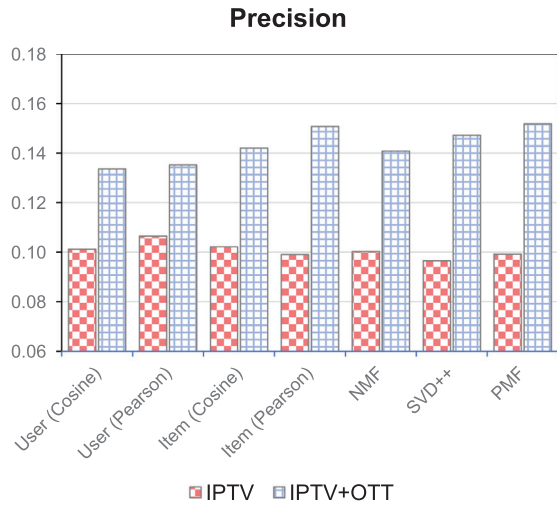

(a) Precision@5

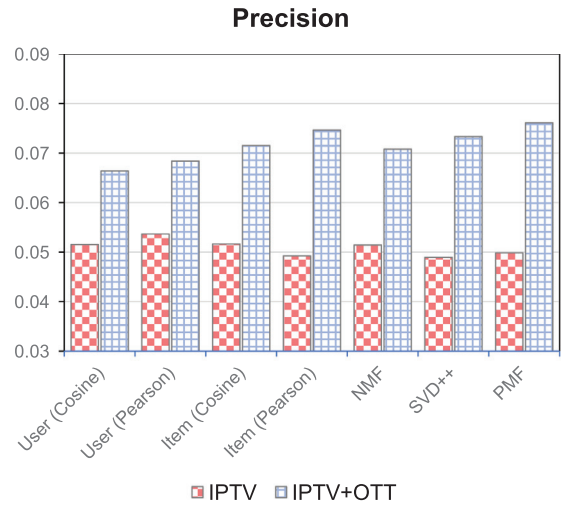

(a) Precision@10

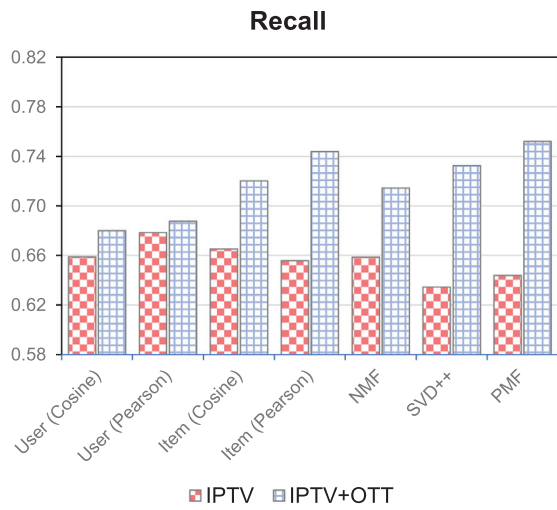

(b) Recall@5

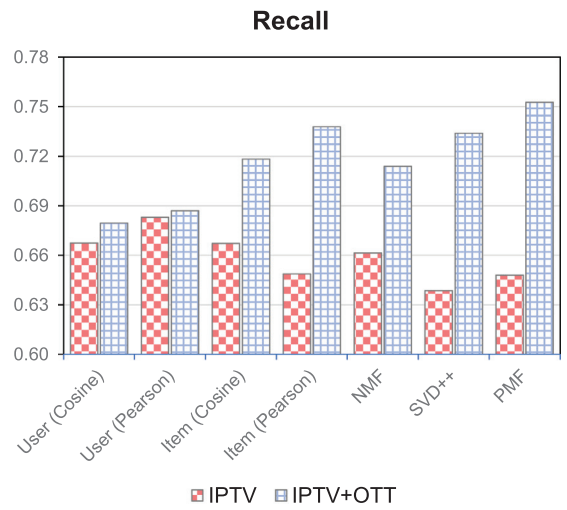

(b) Recall@10

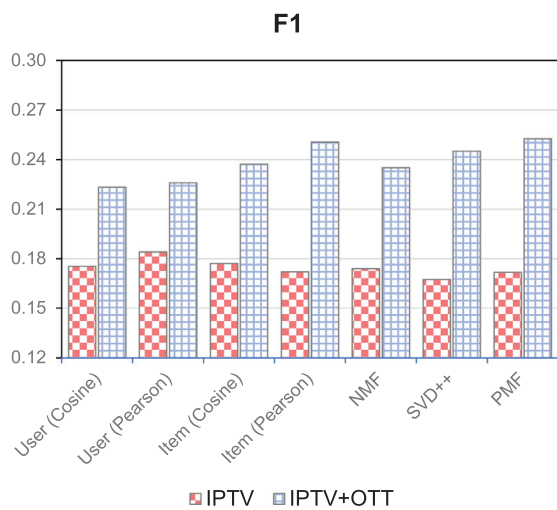

(c) f1-measure@5

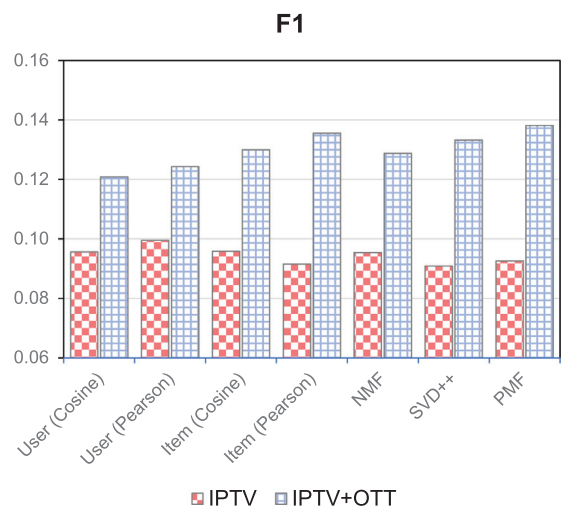

(c) f1-measure@10

Fig. 4. Results of precision, recall, and f1-measure (Number of top k results correspond to 5).

Fig. 5. Results of precision, recall, and f1-measure (Number of top k results correspond to 10).

data in our evaluations; therefore, we verified that PMF guaranteed high effectiveness in the IPTV domain.

6. Discussion

In this study, there are some limitations because the type of provided data was not diverse. First, we only considered a case when IPTV service company serves both IPTV and OTT services but not a case when IPTV service company partners with OTT service company to provide OTT service. In the latter case, it is possible to apply our proposed method if information sharing between different IPTV and OTT companies would be possible. However, without information sharing between two different companies, it is hard to apply our proposed method technically or legally. Furthermore, we utilized PMF as our recommender algorithm and other CF methods as the baseline algorithms, but did not consider tensor factorization even though it is a newly popular algorithm. Tensor factorization was not a suitable algorithm for our VOD recommender system based on explicit preference information and a 2-dimensional matrix (i.e., user-to-item matrix) using this information, because we need an N-dimensional matrix rather than 2-dimensional matrix to utilize it.

7. Conclusion

In this study, we proposed a novel integration method of IPTV and OTT for the IPTV VOD recommender system. The data sparsity problem of the IPTV recommender system could be solved by supplementing the IPTV data with OTT data. In addition, PMF was utilized as an algorithm in our recommender system to guarantee a high-performance recommendation. According to the actual IPTV data in Korea, we conducted comparative evaluations based on various metrics, such as RMSE, MAE, precision, recall, and f1-measure, to validate our explicit information fusion method for IPTV VOD recommendation. The experimental results indicated that the addition of OTT data solved the data sparseness problem and improved the performance of the IPTV VOD recommender system in all recommender algorithms, except RMSE of item-based CF based on PCC. In particular, PMF outperformed the other algorithms and showed higher performance increase in all metrics when supplementing the IPTV data with OTT data.

In the future work, we will intend to extract user's behavior information that improves the performance of VOD recommendation based on tensor factorization. Furthermore, there existed channel recommendation as well as VOD in the IPTV recommender system. Therefore, we will propose an IPTV channel recommender system by collecting the IPTV watching logs of users and measuring the channel preference of users based on these log data.

Authorship statement

All persons who meet authorship criteria are listed as authors, and all authors certify that they have participated sufficiently in the work to take public responsibility for the content, including participation in the concept, design, analysis, writing, or revision of the manuscript. Furthermore, each author certifies that this material or similar material has not been and will not be submitted to or published in any other publication before its appearance in the Expert Systems with Applications.

Declaration of Competing Interest

The authors declare that they have no known competing financial interests or personal relationships that could have appeared to influence the work reported in this paper.

Credit authorship contribution statement

Young-Duk Seo: Conceptualization, Methodology, Validation, Formal analysis, Investigation, Resources, Writing - original draft. **Euijong Lee:** Software, Validation, Formal analysis, Investigation, Visualization. **Young-Gab Kim:** Methodology, Writing - review & editing, Supervision, Project administration, Funding acquisition.

Acknowledgments

This work was supported by Institute of Information & communications Technology Planning & Evaluation (IITP) grant funded by the Korea government (MSIT) (no. 2019-0-00231, Development of artificial intelligence based video security technology and systems for public infrastructure safety). And this work (grants no. C0531694) was supported by Business for Cooperative R&D between Industry, Academy, and Research Institute funded Korea Small and Medium Business Administration in 2018. Finally, all authors are grateful to Zinnaworks Inc. providing IPTV and OTT data for our evaluations.

References

- Adomavicius, G., & Tuzhilin, A. (2005). Toward the next generation of recommender systems: A survey of the state-of-the-art and possible extensions. *IEEE Transactions on Knowledge & Data Engineering (TKDE)*, 17(6), 734–749.
- Alonso, S., Bobadilla, J., Ortega, F., & Moya, R. (2019). Robust model-based reliability approach to tackle shilling attacks in collaborative filtering recommender systems. *IEEE Access*, 7, 41782–41798.
- Bambini, R., Cremonesi, P., & Turrin, R. (2011). A recommender system for an IPTV service provider: A real large-scale production environment. In *Recommender systems handbook* (pp. 299–331). Boston, MA: Springer.
- Bhatt, R. (2009). Vote stuffing control in IPTV-based recommender systems. In *Proceedings of the First International Conference on Intelligent Human Computer Interaction* (pp. 176–183). New Delhi: Springer.
- Bobadilla, J., Ortega, F., Hernando, A., & Gutiérrez, A. (2013). Recommender systems survey. *Knowledge-Based Systems*, 46, 109–132.
- Burke, R. (2002). Hybrid recommender systems: Survey and experiments. *User Modeling and User-Adapted Interaction*, 12(4), 331–370.
- Chang, K. H., Hightower, J., & Kveton, B. (2009). Inferring identity using accelerometers in television remote controls. In *International Conference on Pervasive Computing* (pp. 151–167). Berlin, Heidelberg: Springer.
- Cremonesi, P., & Turrin, R. (2010). Time-evolution of IPTV recommender systems. In *Proceedings of the 8th European Conference on Interactive TV and Video* (pp. 105–114). ACM.
- Cremonesi, P., Turrin, R., & Airoidi, F. (2011). Hybrid algorithms for recommending new items. In *Proceedings of the 2nd international workshop on information heterogeneity and fusion in recommender systems* (pp. 33–40). ACM.
- Dwyer, T., Shim, Y., Lee, H., & Hutchinson, J. (2018). Comparing digital media industries in South Korea and Australia: The case of netflix take-up. *International Journal of Communication*, 12, 20.
- Forsati, R., Mahdavi, M., Shamsfard, M., & Sarwat, M. (2014). Matrix factorization with explicit trust and distrust side information for improved social recommendation. *ACM Transactions on Information Systems (TOIS)*, 32(4), 17.
- Inan, E., Tekbacak, F., & Ozturk, C. (2018). Moreopt: A goal programming based movie recommender system. *Journal of Computational Science*, 28, 43–50.
- Jang, J., Zhao, D., Hong, W., Park, Y., & Yi, M. Y. (2016). Uncovering the underlying factors of smart TV UX over time: A multi-study, mixed-method approach. In *Proceedings of the ACM International Conference on Interactive Experiences for TV and Online Video* (pp. 3–12). ACM.
- Jin, Y., Junhua, G., Suqi, Z., & Jian, Z. (2017). Spark-based distributed multi-features hybrid iptv viewing implicit feedback scoring model. *Procedia computer science*, 111, 441–447.
- Kim, D. (2018). Age of media convergence. In *Media Governance in Korea 1980–2017* (pp. 111–131). Cham: Palgrave Macmillan.
- Kim, J., & Kang, S. (2013). An ontology-based personalized target advertisement system on interactive TV. *Multimedia tools and applications*, 64(3), 517–534.
- Kim, J., Kwon, E., Cho, Y., & Kang, S. (2011). Recommendation system of iptv program using ontology and k-means clustering. In *International Conference on Ubiquitous Computing and Multimedia Applications* (pp. 123–128). Berlin, Heidelberg: Springer.
- Kim, M. W., Kim, E. J., Song, W. M., Song, S. Y., & Khil, A. R. (2012a). Efficient recommendation for smart TV contents. In *International Conference on Big Data Analytics* (pp. 158–167). Berlin, Heidelberg: Springer.
- Kim, M. W., Song, W. M., Song, S. Y., & Kim, E. J. (2012b). Efficient collaborative recommendation with users clustered for IPTV services. In *International Conference on Hybrid Information Technology* (pp. 409–416). Berlin, Heidelberg: Springer.
- Ko, H. G., Kim, E., Ko, I. Y., & Chang, D. (2014). Semantically-based recommendation by using semantic clusters of users' viewing history. In *2014 international conference on big data and smart computing (BIGCOMP)* (pp. 83–87). IEEE.

- Konstas, I., Stathopoulos, V., & Jose, J. M. (2009). On social networks and collaborative recommendation. In *Proceedings of the 32nd international ACM SIGIR conference on Research and development in information retrieval* (pp. 195–202). ACM.
- Koren, Y. (2008). Factorization meets the neighborhood: A multifaceted collaborative filtering model. In *Proceedings of the 14th ACM SIGKDD international conference on Knowledge discovery and data mining* (pp. 426–434). ACM.
- Koren, Y., Bell, R., & Volinsky, C. (2009). Matrix factorization techniques for recommender systems. *Computer*, 8, 30–37.
- Lee, J., Sun, M., & Lebanon, G. (2012). A comparative study of collaborative filtering algorithms. arXiv:1205.3193.
- Luo, X., Zhou, M., Xia, Y., & Zhu, Q. (2014). An efficient non-negative matrix-factorization-based approach to collaborative filtering for recommender systems. *IEEE Transactions on Industrial Informatics*, 10(2), 1273–1284.
- Ma, H. (2013). An experimental study on implicit social recommendation. In *Proceedings of the 36th international ACM SIGIR conference on Research and development in information retrieval* (pp. 73–82). ACM.
- Mnih, A., & Salakhutdinov, R. R. (2008). Probabilistic matrix factorization. In *Advances in neural information processing systems* (pp. 1257–1264).
- Oliveira, R., Silva, T., de Abreu, J. F., & Almeida, M. (2016). Automatic identification in accessible iTV services: Proposal of an IPTV interface. In *Proceedings of the 7th International Conference on Software Development and Technologies for Enhancing Accessibility and Fighting Info-exclusion* (pp. 384–391). ACM.
- Park, E. A. (2018). Business strategies of Korean TV players in the age of Over-The-Top (OTT) video service. *International Journal of Communication*, 12, 22.
- Park, H., Han, K., Yang, J., & Choi, J. K. (2017a). Enhanced metadata creation and utilization for personalized iptv service. In *International Conference on Information Science and Applications* (pp. 763–769). Singapore: Springer.
- Park, K., Choi, J., & Lee, D. (2010). IPTV-VOD program recommendation system using single-scaled hybrid filtering. In *Proceedings of the 10th WSEAS international conference on Signal processing, computational geometry and artificial vision* (pp. 128–133). ACM.
- Park, Y., Oh, J., & Yu, H. (2017b). RecTime: Real-time recommender system for online broadcasting. *Information Sciences*, 409, 1–16.
- Sarwar, B., Karypis, G., Konstan, J., & Riedl, J. (2000). *Application of dimensionality reduction in recommender system-a case study* (No. TR-00-043). Minneapolis: Minnesota Univ Minneapolis Dept of Computer Science.
- Seo, Y. D., Kim, Y. G., Lee, E., & Baik, D. K. (2017). Personalized recommender system based on friendship strength in social network services. *Expert Systems with Applications*, 69, 135–148.
- Song, J., Jang, T., & Sohn, S. Y. (2009). Conjoint analysis for IPTV service. *Expert Systems with Applications*, 36(4), 7860–7864.
- Sumiyoshi, H., Sano, M., Goto, J., Mochizuki, T., Miyazaki, M., Fujii, M., et al. (2010). CurioView: TV recommendations related to content being viewed. In *2010 IEEE International Symposium on Broadband Multimedia Systems and Broadcasting (BMSB)* (pp. 1–6). IEEE.
- Ullah, F., Sarwar, G., & Lee, S. (2014). Social network and device aware personalized content recommendation. *Procedia Technology*, 17, 528–533.
- Vanattenhoven, J., & Geerts, D. (2015). Designing TV recommender interfaces for specific viewing experiences. In *Proceedings of the ACM International Conference on Interactive Experiences for TV and Online Video* (pp. 185–190). ACM.
- Wang, P., Zuo, X., Guo, C., Li, R., Zhao, X., & Luo, C. (2017). A multiobjective genetic algorithm based hybrid recommendation approach. In *2017 IEEE Symposium Series on Computational Intelligence (SSCI)* (pp. 1–6). IEEE.
- Xiao, J., & He, L. (2012). An expandable recommendation system on IPTV. In *International Conference in Swarm Intelligence* (pp. 33–40). Berlin, Heidelberg: Springer.
- Xin, Y., & Steck, H. (2011). Multi-value probabilistic matrix factorization for IPTV recommendations. In *Proceedings of the fifth ACM conference on Recommender systems* (pp. 221–228). ACM.
- Yang, Y., Hu, Q., He, L., Ni, M., & Wang, Z. (2015). Adaptive temporal model for IPTV recommendation. In *International Conference on Web-Age Information Management* (pp. 260–271). Cham: Springer.
- Yang, Y., Liu, C., Li, C., Hu, Y., Niu, Y., & Li, L. (2014, July). The recommendation systems for smart tv. In *Fifth International Conference on Computing, Communications and Networking Technologies (ICCCNT)* (pp. 1–6). IEEE.
- Zhang, R., Deng, Y., & Shi, L. (2017). User research and design for live TV UX in China. In *Adjunct Publication of the 2017 ACM International Conference on Interactive Experiences for TV and Online Video* (pp. 9–14). ACM.
- Zibriczky, D., Petres, Z., Waszlavik, M., & Tikik, D. (2013). EPG content recommendation in large scale: A case study on interactive TV platform. In *2013 12th International Conference on Machine Learning and Applications: Vol. 2* (pp. 315–320). IEEE.